

Jacoflon edelstahldrahtumflochtene PTFE-Schläuche
Jacoflon tuyau en PTFE avec tressage en acier inoxydable
Jacoflon PTFE hoses with stainless steel braid

Technische Daten

Die Flexibilität sowie die Korrosions- und Druckbeständigkeit machen den Jacoflon PTFE-Schlauch zu einem Schlauch für besondere Anwendungen.

Lieferbar sind Schläuche mit Armaturen aus Edelstahl 1.4571 in unterschiedlichen Längen und Ausführungen nach Kundenspezifikation.

Données techniques

La flexibilité ainsi que la résistance à la corrosion et à la pression du tube Jacoflon PTFE le rend idéal pour des applications spéciales. Les tuyaux avec raccords en acier inoxydable 1.4571 sont livrables dans des longueurs et des exécutions les plus variées et selon spécifications du client.

Technical data

Due to its flexibility and the excellent corrosion and pressure resistance the Jacoflon PTFE hose is ideally suited for special applications. The hoses with stainless steel fittings 1.4571 are available in different lengths and designs according to customer specifications .

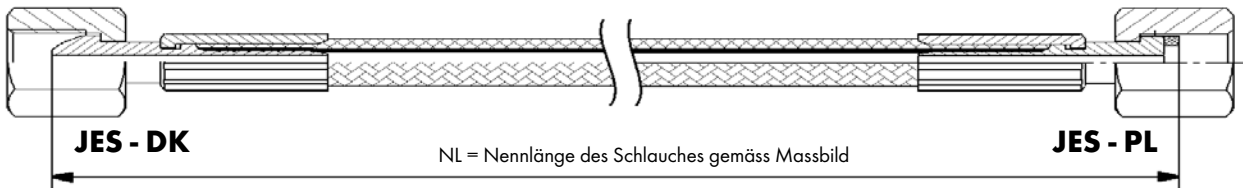
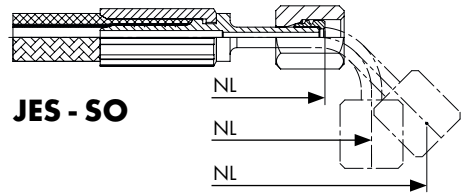
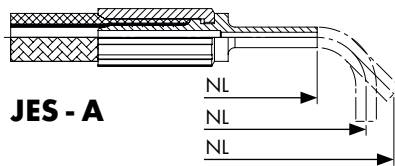
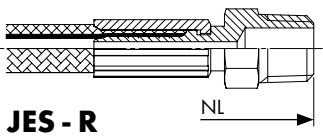

NL = Nennlänge des Schlauches gemäss Massbild

NL = Longueur nominale du tuyau selon plan coté
 NL = Nominal length of tube as per drawing

Bestellbeispiel

Exemple pour commande

Ordering example

1 AQ 1/8 - R 1/8 - A3 x 450

Schlauchtyp Type de tuyau Tube type	1. Anschluss 1. Raccord 1. Fitting	2. Anschluss 2. Raccord 2. Fitting
---	--	--

Schlauchnennlänge mm
 Longueur nominale du tuyau mm
 Nominal length of tube mm

Spezifikationen

Werkstoff: Innenschlauch PTFE, Drahtgeflecht 1.4301
 Temperaturbereich: -60°C bis +250°C

Spécifications

Matériau: tuyau intérieur PTFE, tresse en fil 1.4301
 Plage de température: -60°C à +250°C

Specifications

Material: internal hose PTFE, wire braid 1.4301
 Temperature range: -60°C to +250°C

Schlauch-Längentoleranz in mm

Tolérances du longueur du tuyau mm

Tolerances for tube length mm

mm	0	500	1'000	2'000	3'000	5'000	10'000	20'000
	+5 / -3 mm	+10 / -5 mm	+20 / -10 mm	+70 / -15 mm	+80 / -20 mm	+100 / -30 mm	+150 / -40 mm	

Merkmale

- hohe chemische Beständigkeit
- thermische Stabilität
- absolut ungiftig
- sehr grosse Betriebssicherheit
- lange Lebensdauer
- Anwendungen: Heissdampf, Wasch- und Reinigungsanlagen, Vulkanisierpressen, Hochleistungsölbrenner, Labor- und Medizintechnik, Raumfahrt und Lebensmittelindustrie

Caractéristiques

- bonne résistance chimique
- stabilité thermique
- aucune toxicité
- sécurité de fonctionnement très haute
- longévité
- Applications: Installations de vapeur chaude, stations de lavage, presses de vulcanisation, brûleurs à haute capacité, secteur des laboratoires et médical, industrie alimentaire

Features

- high chemical resistance
- thermal stability
- non-toxic
- high operating safety
- longevity
- Applications: Superheated steam installations, wash- and cleaning stations, vulcanising presses, high-power burners, in laboratories or pharmaceutical labs, foodstuff industry

Druckauswertungsgrad in % des PN

Coefficient de pression en % de PN

Pressure coefficient % of PN

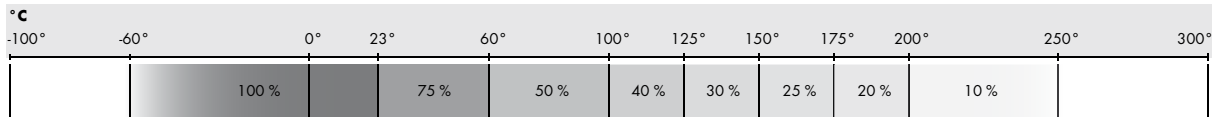

Einbaurichtlinien für Schlauchleitungen

Schlauchleitungen sind so anzuordnen, dass sie leicht eingebaut und kontrolliert werden können; ein Scheuern an anderen Bauteilen ist zu vermeiden. Die angegebenen Mindestbiegeradien sind unbedingt einzuhalten. Bei häufiger Bewegung sind sie zur Verbesserung der Lebensdauer des Schlauches bis zu 50 % zu vergrössern. Jede gerade Schlauchleitung ist grundsätzlich mit Durchhang zu montieren, auch im Hinblick auf eventuelle Längenveränderungen der Schlauchleitung unter Druck. Torsionsbeanspruchung auf den Schlauch ist beim Einbau und im Betrieb zu vermeiden, sonst sind Axialdrehgelenke zu benutzen. Genügende Schlauchlänge vorsehen, damit die Schlauchleitung bei Bewegung der Maschinenteile nicht knickt.

Instructions de montages des tuyaux flexibles

Disposer les tuyaux flexibles de manière à pouvoir les monter et les contrôler facilement ; éviter tout contact avec les autres éléments de construction. Respecter les rayons de courbure minimum indiqués. En cas de mouvement fréquent, les augmenter de 50 % pour améliorer la durée de vie du tuyau. Installer chaque tuyau flexible avec un léger mou, en tenant compte également des éventuels changements de longueur du tuyau flexible sous pression. Eviter les sollicitations en torsion des tuyaux lors du montage et de l'utilisation, sinon utiliser des joints rotatifs axiaux. Prévoir une longueur de tuyau suffisante afin de ne pas plier le tuyau flexible lors du déplacement des parties de la machine.

Installation guidelines for hose lines

Hose lines must be arranged so that they are easy to install and check; chafing on other components must be avoided. It is essential that the stated minimum bending radii are complied with. In case of frequent movement the size of the hose should be increased by up to 50 % in order to improve the lifespan of the hose. Each hose line must be installed so that it sags, taking into consideration any changes in length of the hose line under pressure. Torsional strain on the hose must be avoided during installation and in operation. Otherwise, axial swivel joints should be used. Ensure that the hoses are long enough, so that the hose line does not kink due to the movement of machine components.

Richtige Montage

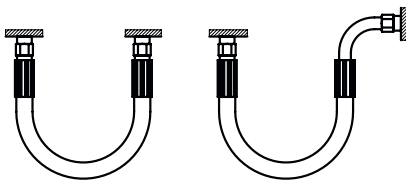

Montage correct



Correct installation

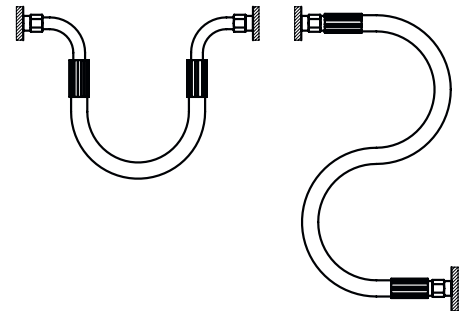

Falsche Montage

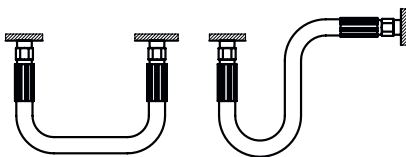

Montage incorrect

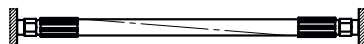

Incorrect installation

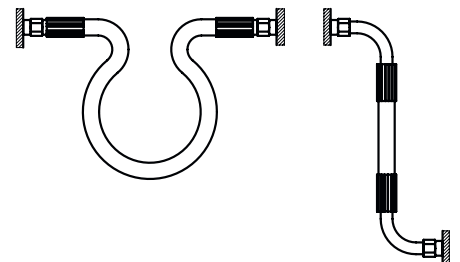

Verdrehwinkel bei gebogenen Armaturen

Werden links und rechts gebogene Armaturen eingesetzt, kann der Verdrehwinkel gewählt werden. Dieser wird, ausgehend vom 1. Anschluss, in Schritten von 45° im Gegenuhrzeigersinn definiert.

Beispiele:

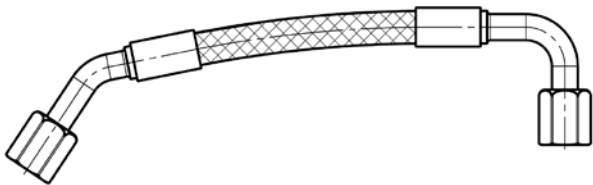

- 1. Anschluss
- 1. Raccord
- 1. Fitting

Angle d'orientation pour raccords coudés

En cas d'utilisation de raccords coudés des deux côtés, l'angle d'orientation peut être sélectionné. Ceci est défini, à partir du 1. raccord, par pas de 45° dans le sens inverse des aiguilles d'une montre.

Exemples:



- 2. Anschluss
- 2. Raccord
- 2. Fitting

Rotation angle for angled fittings

If angled fittings are used on both sides, the rotation angle can be selected. This is defined, starting from the 1. fitting, in steps of 45° counterclockwise.

Examples:

- Verdrehwinkel 0°
- Angle d'orientation 0°
- Rotation angle 0°

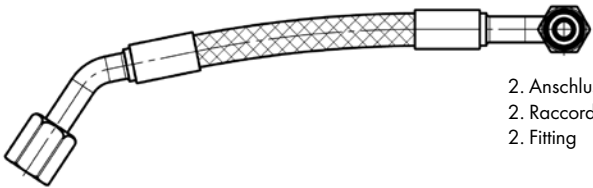

- 1. Anschluss
- 1. Raccord
- 1. Fitting

- 2. Anschluss
- 2. Raccord
- 2. Fitting

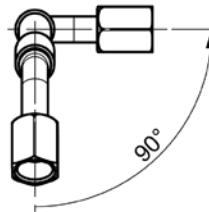

- Verdrehwinkel 90°
- Angle d'orientation 90°
- Rotation angle 90°

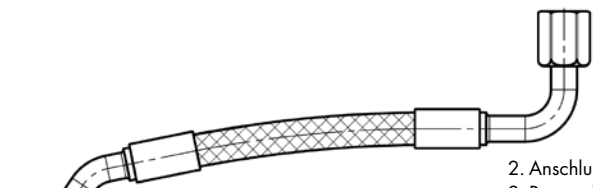

- 1. Anschluss
- 1. Raccord
- 1. Fitting

- 2. Anschluss
- 2. Raccord
- 2. Fitting

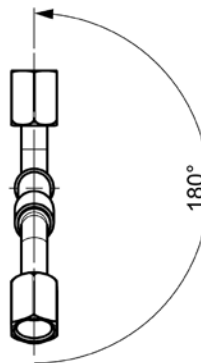

- Verdrehwinkel 180°
- Angle d'orientation 180°
- Rotation angle 180°



- 1. Anschluss
- 1. Raccord
- 1. Fitting

- 2. Anschluss
- 2. Raccord
- 2. Fitting

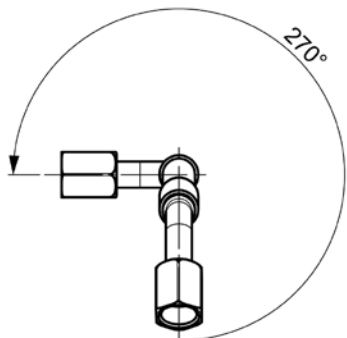

- Verdrehwinkel 270°
- Angle d'orientation 270°
- Rotation angle 270°

Allgemeine Informationen

Permeabilität bei Jacoflon Schläuchen

Die Permeabilität ist der molekulare Transport von einem gasförmigen Medium durch einen physikalischen Festkörper durch:

1. Adsorbierung und Absorbierung auf der hohen Konzentrationsseite
2. Diffusion durch das Festmaterial z.B. Schlauchmaterial (PTFE-Seele) hindurch
3. Resorbierung von der tieferen Konzentrationsseite

Dieses sehr komplexe Problem in Kombination mit Kunststoffen wird zusätzlich negativ beeinflusst durch:

- den Lieferzustand
- die physikalischen Eigenschaften des Kunststoffes
- die chemische Zusammensetzung des Mediums und des verwendeten Kunststoffes

• Hochflexible Qualität HQ

Durch die extrem dünne PTFE-Seele wird eine maximale Flexibilität erreicht. Die dünne Seele führt jedoch zu einer höheren Permeabilität und ist somit nicht ideal für Gasanwendungen.

Permeationskonzentration

Die Differenz der Konzentration über das Medium zur Umgebung ist die treibende Kraft der Permeation und nicht zwingend der Nenndruck des Mediums im Schlauch. Die Permeabilität des Schlauches nimmt mit zunehmender Temperatur exponentiell zu.

Jacoflon in Vakuumanwendungen

Je kleiner die lichte Weite des Schlauches ist, desto eher kann der Schlauch in einer Vakuumanwendung eingesetzt werden. Wobei wir klar von Grobvakuum bis Feinvakuum sprechen. Das Vakuum ist begrenzt durch die Permeabilität des Schlauches sowie das Kollabieren der PTFE-Seele.

Statische Anwendungen

Durch die Permeabilität gegeben sind Anwendungen mit gasförmigen Medien nur empfohlen, wenn eine kontinuierliche Förderung und Druckerzeugung gewährleistet ist. Bsp.: Eine Feuerlöschleitung gefüllt mit 60 bar CO₂ wird über die Zeit Druck verlieren und somit drucklos sein.

Interpretation des Sicherheitsfaktors

Der Sicherheitsfaktor bei Jacoflon Schläuchen wird mit Wasser oder Hydrauliköl mit rascher Druckzunahme ermittelt. Wobei der Druckabfall nicht berücksichtigt wird, sondern nur das Versagen des Schlauches/Geflechtes.

Informations générales

Perméabilité des tuyaux Jacoflon

La perméabilité est le transport moléculaire d'un fluide gazeux au travers d'un corps solide par les procédés suivants:

1. Adsorption et absorption sur l'interface de concentration élevée
2. Diffusion par la matière solide, p. ex. le matériau du tuyau (âme en PTFE)
3. Résorption de l'interface de concentration inférieure

Ce problème très complexe associé aux plastiques subit également l'influence négative des éléments suivants:

- l'état de livraison
- les propriétés physiques du plastique
- la composition chimique du fluide et du plastique utilisé

• Qualité forte flexible HQ

Une flexibilité maximale est obtenue grâce à l'âme en PTFE extrêmement fine. Cependant, l'âme fine conduit à une perméabilité plus élevée et n'est donc pas idéale pour les applications gaz.

Concentration de perméation

La différence de concentration dans le fluide par rapport à l'environnement correspond à la force motrice de la perméation et pas nécessairement à la pression nominale du fluide dans le tuyau.

La perméabilité du tuyau augmente exponentiellement lorsque la température monte.

Jacoflon dans les applications sous vide

Plus le diamètre intérieur du tuyau est petit, plus le tuyau convient pour les applications sous vide. Il s'agit clairement du vide grossier au vide poussé. Le vide est limité par la perméabilité du tuyau et l'affaissement de l'âme PTFE.

Applications statiques

Compte tenu de la perméabilité, les applications avec fluide gazeux ne sont recommandées qu'en cas de transport continu et de production de pression.

Exemple: Un collecteur principal d'incendie contenant 60 bar de CO₂ perdra de la pression au fil du temps et ne sera donc plus sous pression.

Interprétation du coefficient de sécurité

Pour les tuyaux Jacoflon, le coefficient de sécurité est déterminé par une hausse de pression rapide avec de l'eau ou de l'huile hydraulique. La chute de pression n'est pas prise en compte, mais bien le défaut du tuyau/de la tresse.

General information

Permeability of Jacoflon hoses

Permeability is the molecular transport of a gaseous medium through a physical, solid body by:

1. adsorption and absorption on the high concentration side,
2. diffusion through the solid material, e.g. hose material (PTFE core),
3. resorption from the low concentration side.

This very complex problem in combination with plastics is further negatively influenced by:

- the condition as delivered,
- the physical properties of the plastic,
- the chemical compositions of the medium and of the plastic used.

• High flexible quality HQ

Maximum flexibility is achieved by the extremely thin PTFE core. However, the thin core leads to a higher permeability and is therefore not ideal for gas applications.

Permeation concentration

The concentration difference between the medium and the surroundings is the driving force of permeation and not necessarily the nominal pressure of the medium in the hose. The permeability of the hose increases exponentially with increasing temperature.

Jacoflon in vacuum applications

The smaller the inner diameter of the hose, the more suitable it is for use in vacuum applications. It is clear that we speak of rough vacuum to high vacuum. The vacuum is limited by the permeability of the hose and the collapse of the PTFE core.

Static applications

Given by the permeability, applications with gaseous media are recommended only if continuous supply and pressurisation are assured. Example: A fire extinguisher line filled with CO₂ at 60 bar will, over time, lose pressure and eventually become completely depressurised.

Interpretation of the safety factor

The safety factor for Jacoflon hoses is determined for a sudden rise in pressure with water or hydraulic oil. No account is taken of the fall off in pressure but only of the failure of the hose/braid.

Jacoflon Automobilqualität AQ

Jacoflon Qualité automobile AQ

Jacoflon Automobile quality AQ

JF PTFE 1 AQ

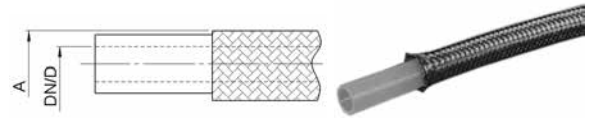

Type -DN	Mat.-Nr.	bar	D	A	B.Radius	L	kg/m
PTFE-1 AQ-1/8	490.3000.100	321	3.4	6.2	38	160.0	0.070
PTFE-1 AQ-3/16	490.3000.200	276	4.9	7.8	64	160.0	0.080

Automobile Qualität mit dickwandigem PTFE-Rohr und einfachem Drahtgeflecht (Inox 1.4301) für erhöhte Druckfestigkeit.

Qualité standard industrie automobile avec tube en PTFE à paroi épaisse et tresse en fil simple (inox 1.4301) pour résistance à la haute pression.

Automotive quality with thick-walled PTFE tube and single braid (inox 1.4301) for increased pressure resistance.

Jacoflon Gasqualität GQ

Jacoflon Qualité gaz GQ

Jacoflon Gas quality GQ

JF PTFE 1 GQ

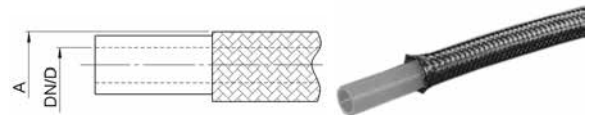

Type -DN	Mat.-Nr.	bar	D	A	B.Radius	L	kg/m
PTFE-1 GQ-1/8	490.4000.100	233	3.5	6.4	38	180.0	0.090

Gasqualität GQ mit molekularverdichtetem PTFE-Rohr und einfachem Drahtgeflecht (Inox 1.4301) - vermindert die Permeabilität für Produkte mit sehr feiner Molekularstruktur.

Qualité gaz GQ avec tube en PTFE à structure moléculaire comprimé et tresse en fil simple (inox 1.4301) - réduit la perméabilité pour produits avec structure moléculaire fine.

Gas quality GQ with molecular compressed PTFE tube and single braid (inox 1.4301) - reduces the permeability for products with very small molecular structure.

Jacoflon Hochflexible Qualität HQ

Jacoflon Qualité forte flexible HQ

Jacoflon High flexible quality HQ

JF PTFE 1 HQ

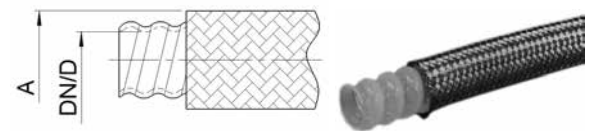

Type -DN	Mat.-Nr.	bar	D	A	B.Radius	L	kg/m
PTFE-1 HQ-3/8 GFL	490.9001.500	138	9.5	14.8	20	210.0	0.250
PTFE-1 HQ-1/2 GFL	490.9001.600	103	12.8	18.8	25	240.0	0.300
PTFE-1 HQ-3/4 GFL	490.9001.800	69	19.1	24.7	64	250.0	0.400
PTFE-1 HQ-1 GFL	490.9001.900	46	25.4	32.8	89	280.0	0.550

Hochflexible Qualität HQ, Wellschlauch mit einfachem Drahtgeflecht (Inox 1.4301).

Qualité HQ, grande flexibilité tube convoluté avec tresse en fil simple (inox 1.4301).

High flexible quality HQ, corrugated hose with single wire jacket (inox 1.4301).

L=Mindestlänge konfektioniert
bar=Arbeitsdruck bei 23°C
DN/D=Rohrinnendurchmesser
A=Rohraussendurchmesser
B.Radius=min. Biegeradius

L=longueur min. assemblée
bar=pression de service à 23°C
DN/D=diamètre intérieur du tube
A=diamètre extérieur du tube
B.Radius=min. rayon de courbure

L=min. length assembled
bar=operation pressure at 23°C
DN/D=tube inside diameter
A=tube outside diameter
B.Radius=min. bend radius

Jacoflon Standardqualität SQ

mit einfachem Drahtgeflecht

Jacoflon Qualité standard SQ

avec tresse en fil simple

Jacoflon Standard quality SQ

with single braid

JF PTFE 1 SQ

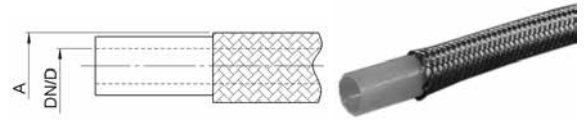

Type -DN	Mat.-Nr.	bar	D	A	B.Radius	L	kg/m
PTFE-1 SQ DN 2,5	490.1000.010	330	2.5	4.5	25	180.0	0.100
PTFE-1 SQ-1/4	490.1000.300	241	6.2	8.6	76	180.0	0.100
PTFE-1 SQ-3/8	490.1000.500	219	8.9	11.7	127	190.0	0.150
PTFE-1 SQ-1/2	490.1000.600	161	12.3	15.4	140	215.0	0.210

Standardqualität SQ mit einfachem Drahtgeflecht (Inox 1.4301).

Qualité standard SQ avec tresse en fil simple (inox 1.4301).

Standard quality SQ with single braid (inox 1.4301).

Jacoflon Standardqualität SQ

mit zweifachem Drahtgeflecht

Jacoflon Qualité standard SQ

avec double tresse

Jacoflon Standard quality SQ

with double braid

JF PTFE 2 SQ

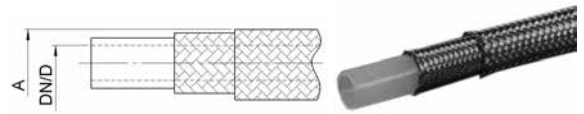

Type -DN	Mat.-Nr.	bar	D	A	B.Radius	L	kg/m
PTFE-2 SQ-3/16	490.2000.200	299	4.9	8.9	64	160.0	0.120
PTFE-2 SQ-1/4	490.2000.300	276	6.2	9.8	76	180.0	0.160
PTFE-2 SQ-3/8	490.2000.500	252	8.9	13.0	127	190.0	0.260
PTFE-2 SQ-1/2	490.2000.600	183	12.4	16.9	140	215.0	0.350
PTFE-2 SQ-5/8	490.2000.700	172	15.2	19.7	165	210.0	0.500
PTFE-2 SQ-3/4	490.2000.800	149	18.9	23.6	203	230.0	0.670
PTFE-2 SQ-1	490.2000.900	92	25.4	31.0	305	230.0	0.860

Standardqualität SQ mit zweifachem Drahtgeflecht (Inox 1.4301) für erhöhte Druck- und Biegefestigkeit.

Qualité standard SQ avec double tresse (inox 1.4301) pour une meilleure résistance à la pression et à la flexion augmentée.

Standard quality SQ with double wire jacket (inox 1.4301) for increased pressure and flexural strength.

L=Mindestlänge konfektioniert
bar=Arbeitsdruck bei 23°C
DN/D=Rohrinnendurchmesser
A=Rohraussendurchmesser
B.Radius=min. Biegeradius

L=longueur min. assemblée
bar=pression de service à 23°C
DN/D=diamètre intérieur du tube
A=diamètre extérieur du tube
B.Radius=min. rayon de courbure

L=min. length assembled
bar=operation pressure at 23°C
DN/D=tube inside diameter
A=tube outside diameter
B.Radius=min. bend radius

Rohrstutzen

für SERTO-Verschraubung

Embout lisse

pour raccords SERTO

Cylindrical stub

for SERTO unions

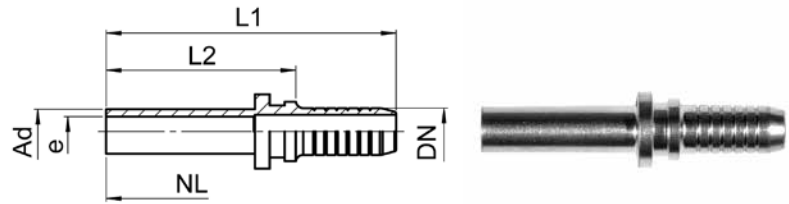
JES-A

Type -DN -Ad	Mat.-Nr.	L1	L2	e	kg/100	1 AQ	1 GQ	1 HQ	1 SQ	2 SQ
JESTR DN2,5 -A6	495.1105.010	29.5	19.5	1.3	0.252				✓	
JESTR 1/8 -A3	495.1105.105	32.0	18.5	1.5	0.770	✓	✓			
JESTR 1/8 -A6	495.1105.115	37.0	23.5	2.0	0.930	✓	✓			
JESTR 3/16 -A6	495.1105.215	39.0	25.5	3.0	1.010	✓				✓
JESTR 1/4 -A6	495.1105.315	39.0	25.5	4.0	1.110				✓	✓
JESTR 1/4 -A8	495.1105.319	41.0	27.5	4.5	1.270				✓	✓
JESTR 3/8 -A10	495.1105.522	46.0	29.5	7.0	1.840				✓	✓
JESTR 3/8 -A12	495.1105.525	47.0	30.5	7.0	2.380				✓	✓
JESTR 1/2 -A12	495.1105.625	50.0	30.5	9.0	3.110				✓	✓
JESTR 1/2 -A15	495.1105.635	50.0	30.5	9.5	3.630				✓	✓
JESTR 5/8 -A18	495.1105.750	58.0	35.5	12.0	6.010					✓
JESTR 3/4 -A22	495.2105.854	58.0	35.5	15.0	7.180					✓
JESTR 1 -A28	495.2105.961	74.0	51.5	21.0	14.320					✓
JESTR 3/8 -A10 HQ	495.8105.522	63.5	30.5	7.0	1.900			✓		
JESTR 3/8 -A12 HQ	495.8105.525	64.5	31.5	7.0	2.200			✓		
JESTR 1/2 -A15 HQ	495.8105.635	73.5	35.5	9.5	3.700			✓		
JESTR 3/4 -A22 HQ	495.8105.854	81.5	38.5	15.0	6.600			✓		
JESTR 1 -A28 HQ	495.8105.961	100.0	53.5	20.0	15.900			✓		

Rohrstutzen 45°

für SERTO-Verschraubung

Embout lisse 45°

pour raccords SERTO

Cylindrical stub 45°

for SERTO unions

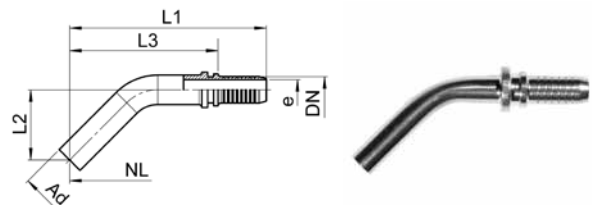
JES-A 45°

Type -DN -Ad	Mat.-Nr.	L1	L2	L3	e	kg/100	1 AQ	1 GQ	1 HQ	1 SQ	2 SQ
JESTR 1/8 -A6 45°	495.1145.115	48.5	16.0	35.0	2.0	0.600	✓	✓			
JESTR 3/16 -A6 45°	495.1145.215	48.5	16.0	35.0	2.8	0.720	✓				✓
JESTR 1/4 -A6 45°	495.1145.315	48.5	16.0	35.0	4.0	0.800				✓	✓
JESTR 1/4 -A8 45°	495.1145.319	58.0	20.0	45.0	4.5	1.480				✓	✓
JESTR 3/8 -A10 45°	495.1145.522	67.0	25.0	50.5	7.0	2.260				✓	✓
JESTR 3/8 -A12 45°	495.1145.525	76.0	29.0	59.5	7.0	3.080				✓	✓
JESTR 1/2 -A12 45°	495.1145.625	78.5	30.0	59.0	9.5	3.250				✓	✓
JESTR 1/2 -A15 45°	495.1145.635	97.0	40.0	77.0	9.5	5.540				✓	✓

 NL=Nennlänge des Schlauches gemäß Massbild
 DN/D=Rohrinnendurchmesser

✓=Kombinationsmöglichkeit Armatur / Schlauch

 NL=longueur nominale du tuyau selon plan coté
 DN/D=diamètre intérieur du tube

✓=possibilité de combinaison raccord / tuyaux

 NL=nominal length of tube as per drawing
 DN/D=tube inside diameter

✓=possible combinations fitting / hose

Rohrstutzen 90°

für SERTO-Verschraubung

Embout lisse 90°

pour raccords SERTO

Cylindrical stub 90°

for SERTO unions

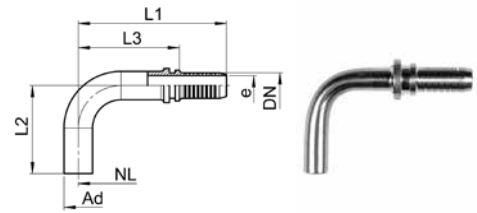

JES-A 90°

Type -DN -Ad	Mat.-Nr.	L1	L2	L3	e	kg/100	1 AQ	1 GQ	1 HQ	1 SQ	2 SQ
JESTR 1/8 -A6 90°	495.1195.115	37.0	22.0	23.5	2.0	0.600	✓	✓			
JESTR 3/16 -A6 90°	495.1195.215	37.0	22.0	23.5	2.8	0.720	✓				✓
JESTR 1/4 -A6 90°	495.1195.315	37.0	22.0	23.5	4.5	0.800				✓	✓
JESTR 1/4 -A8 90°	495.1195.319	44.0	29.0	30.5	4.5	1.480				✓	✓
JESTR 3/8 -A10 90°	495.1195.522	49.0	36.0	32.5	7.0	2.260				✓	✓
JESTR 3/8 -A12 90°	495.1195.525	57.0	39.0	40.5	7.0	3.080				✓	✓
JESTR 1/2 -A12 90°	495.1195.625	60.0	39.0	41.0	9.5	3.250				✓	✓
JESTR 1/2 -A15 90°	495.1195.635	69.5	62.0	50.0	9.5	5.540				✓	✓

Rohrstutzen

mit SERTO-Armaturenanschluss

Embout lisse

avec ecrou de raccord SERTO

Cylindrical stub

with SERTO nut connection

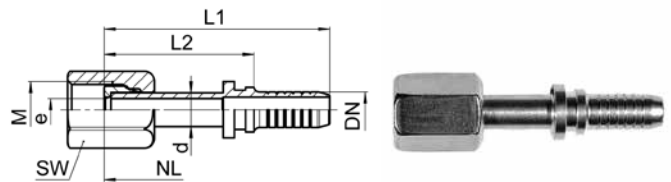

JES-SO

Type -DN -d -M	Mat.-Nr.	bar	SW	L1	L2	e	kg/100	1 AQ	1 GQ	1 HQ	1 SQ	2 SQ
JESSO DN2,5 -6 -M10x1	497.1105.010	200	12	31.0	21.0	1.3	1.100				✓	
JESSO 1/8 -3 -M6x0.75	497.1105.105	250	8	33.0	19.5	1.5	1.040	✓	✓			
JESSO 1/8 -6 -M10x1	497.1105.115	200	12	38.5	25.0	2.0	1.720	✓	✓			
JESSO 3/16 -6 -M10x1	497.1105.215	200	12	40.5	27.0	3.0	1.800	✓				✓
JESSO 1/4 -6 -M10x1	497.1105.315	200	12	40.5	27.0	4.0	1.900				✓	✓
JESSO 1/4 -8 -M12x1	497.1105.319	200	14	42.5	29.0	4.5	2.320				✓	✓
JESSO 3/8 -10 -M14x1	497.1105.522	160	17	47.5	31.0	7.0	3.620				✓	✓
JESSO 3/8 -12 -M16x1	497.1105.525	160	19	48.5	32.0	7.0	4.590				✓	✓
JESSO 1/2 -12 -M16x1	497.1105.625	160	19	51.5	32.0	9.0	5.320				✓	✓
JESSO 1/2 -15 -M20x1.5	497.1105.635	100	24	51.5	32.0	9.5	7.840				✓	✓
JESSO 3/8 -18 -M24x1.5	497.1105.750	100	30	59.5	37.0	12.0	11.060					✓
JESSO 3/4 -22 -M28x1.5	497.2105.854	64	32	59.5	37.0	15.0	15.340					✓
JESSO 1 -28 -M36x2	497.2105.961	40	41	76.0	53.5	21.0	29.320					✓
JESSO 3/8 -10 -M14x1 HQ	497.8105.522	138	17	65.0	32.0	7.0	4.200			✓		
JESSO 3/8 -12 -M16x1 HQ	497.8105.525	138	19	66.0	33.0	7.0	5.400			✓		
JESSO 1/2 -15 -M20x1.5 HQ	497.8105.635	100	24	75.0	37.0	9.5	9.100			✓		
JESSO 3/4 -22 -M28x1.5 HQ	497.8105.854	64	32	83.0	40.0	15.0	16.600			✓		
JESSO 1 -28 -M36x2 HQ	497.8105.961	40	41	102.0	55.5	20.0	34.400			✓		

Bei Kombinationen Jacoflon-Schlauch mit JES-SO Armaturen gilt die jeweils schwächere Druckangabe.

Pour des combinaisons de tuyaux Jacoflon équipés de raccords JES-SO, il faut prendre en compte la pression la plus faible des composants.

For combinations Jacoflon tube with JES-SO unions, the lower pressure value applies.

NL=Nennlänge des Schlauches gemäß Massbild
DN/D=Rohrinnendurchmesser
✓=Kombinationsmöglichkeit Armatur / Schlauch

NL=longueur nominale du tuyau selon plan coté
DN/D=diamètre intérieur du tube
✓=possibilité de combinaison raccord / tuyaux

NL=nominal length of tube as per drawing
DN/D=tube inside diameter
✓=possible combinations fitting / hose

Rohrstutzen 45°

mit SERTO-Armaturenanschluss

Embout lisse 45°

avec ecrou de raccord SERTO

Cylindrical stub 45°

with SERTO nut connection

JES-SO 45°

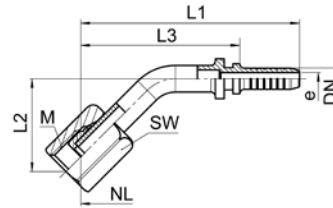

Type -DN -d -M	Mat.-Nr.	bar	SW	L1	L2	L3	e	kg/100	1AQ	1GQ	1HQ	1SQ	2SQ
JESSO 1/8 -6 -M10x1 45°	497.1145.115	200	12	49.5	20.0	36.0	2.0	1.390	✓	✓			
JESSO 3/16 -6 -M10x1 45°	497.1145.215	200	12	49.5	20.0	36.0	2.8	1.510	✓				✓
JESSO 1/4 -6 -M10x1 45°	497.1145.315	200	12	49.5	20.0	36.0	4.0	1.590				✓	✓
JESSO 1/4 -8 -M12x1 45°	497.1145.319	200	14	59.0	25.0	45.5	4.5	1.850				✓	✓
JESSO 3/8 -10 -M14x1 45°	497.1145.522	160	17	68.0	30.0	51.5	7.0	4.040				✓	✓
JESSO 3/8 -12 -M16x1 45°	497.1145.525	160	19	77.0	33.5	60.5	7.0	4.470				✓	✓
JESSO 1/2 -12 -M16x1 45°	497.1145.625	160	19	79.5	34.5	60.0	9.5	5.460				✓	✓
JESSO 1/2 -15 -M20x1.5 45°	497.1145.635	100	24	98.0	45.5	78.0	9.5	7.460				✓	✓

Bei Kombinationen Jacoflon-Schlauch mit JES-SO Armaturen gilt die jeweils schwächere Druckangabe.

Pour des combinaisons de tuyaux Jacoflon équipés de raccords JES-SO, il faut prendre en compte la pression la plus faible des composants.

For combinations Jacoflon tube with JES-SO unions, the lower pressure value applies.

Rohrstutzen 90°

mit SERTO-Armaturenanschluss

Embout lisse 90°

avec ecrou de raccord SERTO

Cylindrical stub 90°

with SERTO nut connection

JES-SO 90°

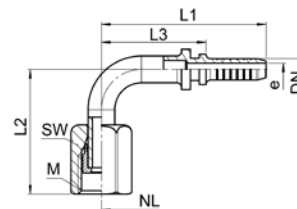

Type -DN -d -M	Mat.-Nr.	bar	SW	L1	L2	L3	e	kg/100	1AQ	1GQ	1HQ	1SQ	2SQ
JESSO 1/8 -6 -M10x1 90°	497.1195.115	200	12	37.0	29.0	23.5	2.0	1.390	✓	✓			
JESSO 3/16 -6 -M10x1 90°	497.1195.215	200	12	37.0	29.0	23.5	2.8	1.510	✓				✓
JESSO 1/4 -6 -M10x1 90°	497.1195.315	200	12	37.0	29.0	23.5	4.5	1.590				✓	✓
JESSO 1/4 -8 -M12x1 90°	497.1195.319	200	14	44.0	32.5	30.5	4.5	1.850				✓	✓
JESSO 3/8 -10 -M14x1 90°	497.1195.522	160	17	49.0	42.5	32.5	7.0	4.040				✓	✓
JESSO 3/8 -12 -M16x1 90°	497.1195.525	160	19	57.0	45.5	40.5	7.0	4.470				✓	✓
JESSO 1/2 -12 -M16x1 90°	497.1195.625	160	19	60.0	46.5	40.5	9.5	5.460				✓	✓
JESSO 1/2 -15 -M20x1.5 90°	497.1195.635	100	24	69.5	62.0	50.0	9.5	7.460				✓	✓

Bei Kombinationen Jacoflon-Schlauch mit JES-SO Armaturen gilt die jeweils schwächere Druckangabe.

Pour des combinaisons de tuyaux Jacoflon équipés de raccords JES-SO, il faut prendre en compte la pression la plus faible des composants.

For combinations Jacoflon tube with JES-SO unions, the lower pressure value applies.

Stutzen

mit konischem Anschlussgewinde

Raccord

avec adaptateur mâle conique

Connector

with conical male adaptor

JES-R

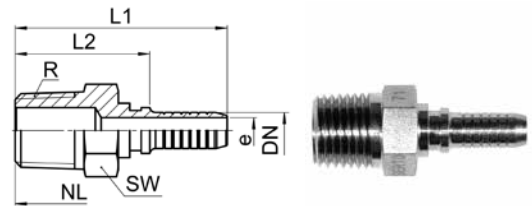

Type -DN -R	Mat.-Nr.	SW	L1	L2	e	kg/100	1 AQ	1 GQ	1 HQ	1 SQ	2 SQ
JESTA 1/8 -1/8	495.1605.110	10	32.0	18.5	2.0	1.260	✓	✓			
JESTA 3/16 -1/8	495.1605.210	10	32.0	18.5	3.0	1.310	✓				✓
JESTA 3/16 -1/4	495.1605.217	14	37.0	23.5	3.0	1.940	✓				✓
JESTA 1/4 -1/4	495.1605.317	14	37.0	23.5	4.5	2.320				✓	✓
JESTA 3/8 -3/8	495.1605.520	17	42.0	25.5	7.0	3.760				✓	✓
JESTA 1/2 -1/2	495.1605.630	22	48.0	28.5	9.5	6.570				✓	✓
JESTA 5/8 -3/4	495.1605.750	27	54.0	31.5	12.0	10.380					✓
JESTA 3/4 -3/4	495.2605.850	27	55.0	32.5	15.0	12.980					✓
JESTA 1 -1	495.2605.960	36	61.0	38.5	21.0	22.940					✓
JESTA 3/8 -3/8 HQ	495.8605.520	17	59.5	26.5	7.0	3.500			✓		
JESTA 1/2 -1/2 HQ	495.8605.630	22	69.5	31.5	9.5	6.900			✓		
JESTA 3/4 -3/4 HQ	495.8605.850	27	77.5	34.5	15.0	12.400			✓		
JESTA 1 -1 HQ	495.8605.960	36	87.0	40.5	20.0	25.200			✓		

Stutzen mit Universaldichtkegel 60°

mit Überwurfmutter

Raccord avec cône d'étanchéité 60°

avec écrou

Connector with conical sealing nipple 60°

with union nut

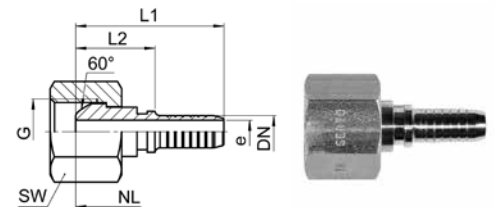

JES-DK

Type -DN -G	Mat.-Nr.	SW	L1	L2	e	kg/100	1 AQ	1 GQ	1 HQ	1 SQ	2 SQ
JESDK 60° -1/8 -1/8	497.1355.110	14	28.0	14.5	2.0	2.050	✓	✓			
JESDK 60° -3/16 -1/4	497.1355.217	17	29.0	15.5	3.0	3.010	✓				✓
JESDK 60° -1/4 -1/4	497.1355.317	17	29.0	15.5	4.5	3.030				✓	✓
JESDK 60° -3/8 -3/8	497.1355.520	19	33.0	16.5	7.0	3.780				✓	✓
JESDK 60° -1/2 -1/2	497.1355.630	24	38.0	18.5	9.5	6.720				✓	✓
JESDK 60° -5/8 -3/4	497.1355.750	32	39.0	16.5	12.0	11.970					✓
JESDK 60° -3/4 -3/4	497.2355.850	32	39.0	16.5	15.0	11.710					✓
JESDK 60° -1 -1	497.2355.960	41	40.0	17.5	21.0	21.260					✓
JESDK 60° -3/8 -3/8 HQ	497.8355.520	19	50.5	17.5	7.0	3.600			✓		
JESDK 60° -1/2 -1/2 HQ	497.8355.630	24	58.5	20.5	9.5	6.600			✓		
JESDK 60° -3/4 -3/4 HQ	497.8355.850	32	61.0	18.0	15.0	11.100			✓		
JESDK 60° -1 -1 HQ	497.8355.960	41	66.0	19.5	20.0	22.800			✓		

NL=Nennlänge des Schlauches gemäß Massbild
 DN/D=Rohrinnendurchmesser
 ✓=Kombinationsmöglichkeit Armatur / Schlauch

NL=longueur nominale du tuyau selon plan coté
 DN/D=diamètre intérieur du tube
 ✓=possibilité de combinaison raccord / tuyaux

NL=nominal length of tube as per drawing
 DN/D=tube inside diameter
 ✓=possible combinations fitting / hose

45° Stutzen mit Universaldichtkegel 60°

mit Überwurfmutter

Raccord 45° avec cône d'étanchéité 60°

avec écrou

45° connector with conical sealing nipple 60°

with union nut

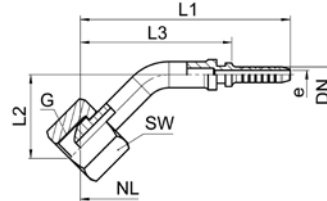

JES-DK 45°

Type -DN -G	Mat.-Nr.	SW	L1	L2	L3	e	kg/100	1 AQ	1 GQ	1 HQ	1 SQ	2 SQ
JESDK 60° -1/8 -1/8 45°	497.1345.110	14	48.5	19.5	35.0	2.0	1.900	✓	✓			
JESDK 60° -1/4 -1/4 45°	497.1345.317	17	54.5	23.5	41.0	4.0	3.350				✓	✓
JESDK 60° -3/8 -3/8 45°	497.1345.520	19	69.5	23.5	53.0	7.0	4.400				✓	✓
JESDK 60° -1/2 -1/2 45°	497.1345.630	24	92.0	31.0	72.5	9.0	10.300				✓	✓

90° Stutzen mit Universaldichtkegel 60°

mit Überwurfmutter

Raccord 90° avec cône d'étanchéité 60°

avec écrou

90° connector with conical sealing nipple 60°

with union nut

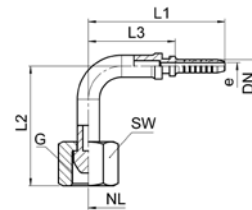

JES-DK 90°

Type -DN -G	Mat.-Nr.	SW	L1	L2	L3	e	kg/100	1 AQ	1 GQ	1 HQ	1 SQ	2 SQ
JESDK 60° -1/8 -1/8 90°	497.1395.110	14	33.0	30.5	19.5	2.0	1.900	✓	✓			
JESDK 60° -1/4 -1/4 90°	497.1395.317	17	38.5	35.0	25.0	4.0	3.350				✓	✓
JESDK 60° -3/8 -3/8 90°	497.1395.520	19	50.5	46.5	34.0	7.0	4.400				✓	✓
JESDK 60° -1/2 -1/2 90°	497.1395.630	24	66.0	49.0	46.5	9.0	10.300				✓	✓

Stutzen mit Planfläche mit PTFE-Dichtring

mit Überwurfmutter

Raccord avec surface plane avec joint torique en PTFE

avec écrou

Connector with flat face end with PTFE gasket

with union nut

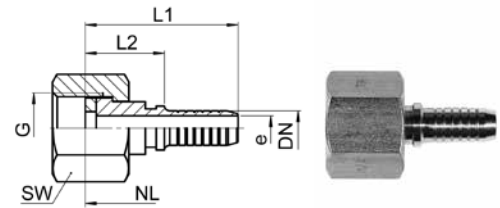
JES-PL

Type -DN -G	Mat.-Nr.	SW	L1	L2	e	kg/100	1 AQ	1 GQ	1 HQ	1 SQ	2 SQ
JESPL -1/8 -1/8	497.1365.110	14	26.5	13.0	2.0	1.980	✓	✓			
JESPL -3/16 -1/4	497.1365.217	17	28.0	14.5	3.0	2.910	✓				✓
JESPL -1/4 -1/4	497.1365.317	17	28.0	14.5	4.5	2.940				✓	✓
JESPL -3/8 -3/8	497.1365.520	19	31.0	14.5	7.0	3.590				✓	✓
JESPL -1/2 -1/2	497.1365.630	24	34.0	14.5	9.5	6.240				✓	✓
JESPL -5/8 -3/4	497.1365.750	32	36.0	13.5	12.0	11.110					✓
JESPL -3/4 -3/4	497.2365.850	32	37.0	14.5	15.0	11.320					✓
JESPL -1 -1	497.2365.960	41	38.0	15.5	21.0	20.620					✓
JESPL -3/8 -3/8 HQ	497.8365.520	19	48.5	17.5	7.0	3.400			✓		
JESPL -1/2 -1/2 HQ	497.8365.630	24	55.0	17.0	9.5	6.200			✓		
JESPL -3/4 -3/4 HQ	497.8365.850	32	60.0	17.0	15.0	10.900			✓		
JESPL -1 -1 HQ	497.8365.960	41	64.0	17.5	20.0	22.000			✓		

45° Stutzen mit Planfläche mit PTFE-Dichtring

mit Überwurfmutter

Raccord 45° avec surface plane avec joint torique en PTFE

avec écrou

45° connector with flat face end with PTFE gasket

with union nut

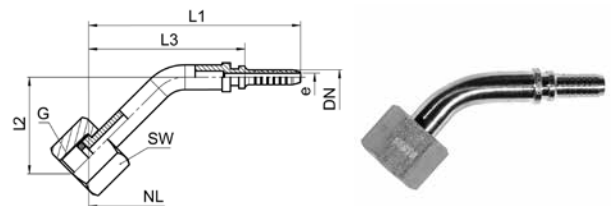
JES-PL 45°

Type -DN -G	Mat.-Nr.	SW	L1	L2	L3	e	kg/100	1 AQ	1 GQ	1 HQ	1 SQ	2 SQ
JESPL -1/8 -1/8 45°	497.1340.110	14	53.0	20.0	40.0	2.0	1.950	✓	✓			
JESPL -1/4 -1/4 45°	497.1340.317	17	54.5	23.0	41.0	4.0	3.250				✓	✓
JESPL -3/8 -3/8 45°	497.1340.520	19	68.0	25.0	52.0	7.0	4.100				✓	✓
JESPL -1/2 -1/2 45°	497.1340.630	24	90.0	31.5	70.5	9.0	6.800				✓	✓

90° Stutzen mit Planfläche mit PTFE-Dichtring

mit Überwurfmutter

Raccord 90° avec surface plane avec joint torique en PTFE

avec écrou

90° connector with flat face end with PTFE gasket

with union nut

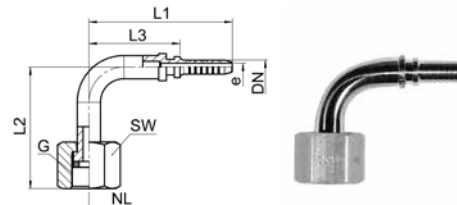

JES-PL 90°

Type -DN -G	Mat.-Nr.	SW	L1	L2	L3	e	kg/100	1AQ	1GQ	1HQ	1SQ	2SQ
JESPL -1/8 -1/8 90°	497.1390.110	14	42.0	28.5	28.5	2.0	1.950	✓	✓			
JESPL -1/4 -1/4 90°	497.1390.317	17	38.5	34.0	25.0	4.0	3.250				✓	✓
JESPL -3/8 -3/8 90°	497.1390.520	19	50.5	34.5	34.0	7.0	4.100				✓	✓
JESPL -1/2 -1/2 90°	497.1390.630	24	67.0	46.5	47.5	9.0	6.800				✓	✓

Dichtscheibe PTFE

für Planfläche

Joint plat en PTFE

pour surface plane

PTFE gasket

for flat face end

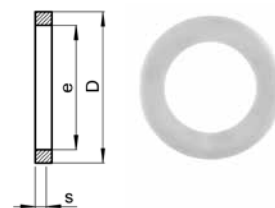

J-PTFE-SCHEIBE

Type	Mat.-Nr.	D	e	s	kg/100
J-PTFE-Scheibe: 1/8 8/5x1,5	496.1808.110	8.0	5.0	1.50	0.100
J-PTFE-Scheibe: 1/4 1 1/8x2	496.1808.317	11.0	6.0	2.00	0.100
J-PTFE-Scheibe: M14x1,5 12/7x2	496.1808.319	12.0	7.0	2.00	0.100
J-PTFE-Scheibe: 3/8 14/9x2	496.1808.520	14.0	9.0	2.00	0.100
J-PTFE-Scheibe: 1/2 16/10x2	496.1808.525	16.0	10.0	2.00	0.100
J-PTFE-Scheibe: 3/4 18/12x2	496.1808.630	18.0	12.0	2.00	0.100
J-PTFE-Scheibe: M22x1,5 19.5/12x2	496.1808.632	19.5	12.0	2.00	0.100
J-PTFE-Scheibe: 3/4 24/18x2	496.2808.850	24.0	18.0	2.00	0.100
J-PTFE-Scheibe: 1 30/20x2	496.2808.960	30.0	20.0	2.00	0.100